

Saturn B/M Enhanced Functions

Operator's Manual

Standard

- *Charge Tone*
- *Traffic Log*
- *Access Code*

Optional

- *Precharge*
- *Restricted LES*
- *Restricted Dialing*
- *Cryptophone STUIII/STUIIB*
- *Credit Card Phone*

Chapter 1. Introduction

About Enhanced Functions	1.1
Protection	1.2
Renter/Owner Level	1.3
Password	1.5

Chapter 2. Standard

Charge Tone	2.1
Traffic Logging	2.3
Access Code	2.13

Chapter 3. Optional

Precharge	3.1
Restricted LES	3.3
Restricted Dialing	3.4
Cryptophone STU III and STU IIB	3.5
Credit Card Phone	3.6

APPENDIX – Overview of Functions

Nera SatCom AS reserves the right to change the design and specifications of the equipment without notice.

1. Introduction

2. Standard

3. Optional

Appendix

About Enhanced Functions 1.1
Protection 1.2
Renter/Owner Level 1.3
Password 1.5

Standard Enhanced Functions

The following Enhanced Functions are available as standard for Saturn B and Saturn M terminals:

- **Charge tone**, which sends a tone on selected telephone ports when charging starts.
- **Traffic log**, which logs traffic data from selected telephone ports and provides detailed printout.
- **Access code**, which allocates a personal 1-8 digit code to up to 100 authorized users. The code opens the system for one call.

Optional Enhanced Functions

The Enhanced Functions below are available as options:

- **Precharge**, which allows preprogramming the Saturn M or B terminal with a maximum total call duration. The maximum call duration can be extended by the owner.
- **Restricted LES**, which allows the owner to lock the terminal to one specific LES per Ocean Region.
- **Restricted Dialing**, which allows calls to preset short numbers only.
- **STU III and STU IIB**, which prepares selected port(s) for use with encrypted telephone.
- **Credit Card Phone**, which prepares selected port(s) for use with credit card telephone.

Activation of these functions requires individual opening keys provided when purchasing the functions.

Optional Data and Telex Functions

Data link and telex functions are also available as options:

- **High Speed Data, HSD**, which offers 56/64 kbps full duplex or simplex link with terrestrial ISDN networks (Saturn B only).
- **Asynchronous Data, ASD**, which offers data transmission at 2.4 kbps (Saturn M) or 9.6 kbps (Saturn B) via its built-in modem.
- **Telex**, simplex and duplex (Saturn B only).

See separate manuals.

Installation

Enhanced Functions are activated using the "Enhanced Setup" function no. 89.

Only Enhanced Functions that have been activated are listed when searching through the main menu "Enhanced Functions" no.8.

Functions that are not yet activated appear as "PASSIVE" when opening the "Enhanced Setup" function no.89.

See appendix for an overview of Saturn B/M functions.

Protection

General

Two password protected user levels are provided in addition to USER and OPERATOR level:

- **RENTER**, and
- **OWNER**

A common default password (1 2 3 4 5 6) facilitates the activation of Enhanced Functions for new users (see "[Password](#)").

Warning! An individual OWNER password must be entered to protect the equipment against unauthorized use. The password must be stored in a safe place.

For safety purposes, protect all telephone ports, see "[Access Code](#)".

Up to three different **operation rights** can be assigned with selectable access level to each Enhanced Function:

- **SETUP OPERATION** – allows such as selection of ports.
Default access level: OWNER.
- **UPDATE OPERATION** – such as entering/deletion of data.
Default access level: OWNER.
- **VIEW OPERATION** – such as display readout and printout.
Default access level: OPERATOR

When activating a function, the access level required to operate each right can be seen in the display when pressing MORE/HELP.

See example below.

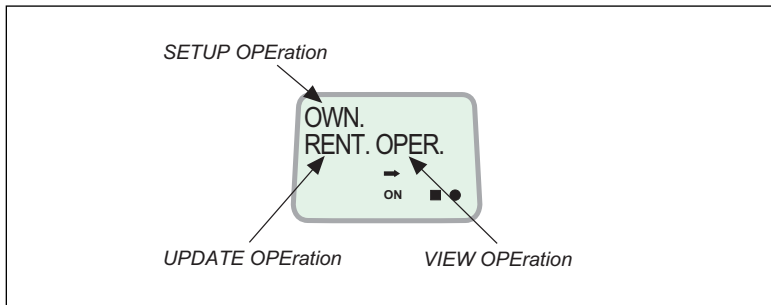

Setup operations can be accessed from RENTER or OWNER level only.

General

The Saturn M/B terminals provide the following access levels in addition to USER (1) level and OPERATOR (2) level:

- **RENTER (3)**, and
- **OWNER (4)**

The RENTER and OWNER levels are protected by passwords. The default password for both levels is **1 2 3 4 5 6**.

Password protection can be used to restrict operative functions to different parameter levels, e.g.:

- level 4 (OWNER) allowed to change setup.
- level 3 (RENTER) allowed to read data.
- level 2 (OPERATOR) given no access to reading or setup.
- level 1 (USER) has standard minimum operational functions.

These restrictions can be applied according to function, e.g.:

The RENTER level can be allowed to configure the traffic log, but restricted to reading only in the access code function.

An individual password may be assigned to each level using the "SET PASSWORD" function no.13, see "Password".

To Set Access Level:

1 Select **SET USER LEVEL** function (12):



2 Display the current level:



3 Key in operator level ref. number, e.g. 3 (RENTER):
3=RENTER, 4=OWNER



4 Key in the current password for this level (the default password is **1 2 3 4 5 6**):



5 The terminal is now set to **RENTER LEVEL**:

*This level is active until a new level is set or the terminal is switched off. Therefore, set the level back to **USER** when finished with your operations.*



and revert to IDLE:



Renter/Owner Level Cont'd

Optional Functions

When purchasing one or a set of Optional Enhanced Functions, an "Opening Key" will be provided that cause the function(s) to be installed. Proceed as under "**To Set Access Level**":

- 1** Select **SET USER LEVEL** function (12)
- 2** Display current level
- 3** At the "LEVEL" prompt, key in **5 9 6**.
- 4** At the "PASSWORD" prompt, key in the "Opening Key" provided by the agent.
The function(s) are now installed.
- 5** Activate the function using the **ENHANCED SETUP** function (89) described later in this manual.

General

The RENTER and OWNER levels are protected by passwords. The default password for both user levels is **1 2 3 4 5 6**.

The password may be changed individually to any password containing at least 4 digits. The owner may change password for both OWNER level and RENTER level, whilst the renter may change password for the renter level only.

Setting Passwords from OWNER level

1 Select **SET PASSWORD** function (**13**):



2 Display current level (OWNER):

Note! Pressing MORE/HELP reveals a restore code that allows the password to be reset to default: 1 2 3 4 5 6. See "Regaining RENTER Default Password" on next page.

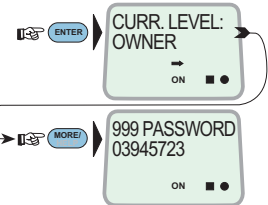

3 Select required level, e.g. 3:
3=RENTER, 4=OWNER



4 Key in new RENTER password, e.g. 1 2 3 4 :
Minimum 4 digits



5 Verify RENTER password:



6 Select required level, e.g. 3:
3=RENTER, 4=OWNER

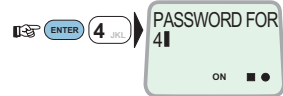

7 Key in new OWNER password, e.g. 1 2 3 4 5:



8 Verify the OWNER password:



and revert to IDLE:



Password Cont'd

Setting Password from RENTER Level

The procedure below assumes that the Saturn terminal is set in RENTER access level, see "[Renter/Owner Level](#)".

1 Select **SET PASSWORD** function (13):



2 Current level:



3 Key in new RENTER password, e.g. 1 2 3 4 :



4 Verify RENTER password:



The verified password is correct:

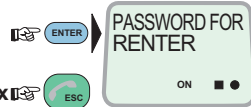

Revert to IDLE:



Regaining Default RENTER Password

If accidentally losing the password, it can be reset to the default password 1 2 3 4 5 6.

Proceed as under "[Renter/Owner Level: To Set Access Level](#)".

- 1** Select **SET USER LEVEL** function (12).
- 2** Display current level.
- 3** At the "LEVEL" prompt, key in **9 9 9**.
- 4** At the "PASSWORD" prompt, key in the restore code provided by the agent.
- 5** The RENTER password is now reset to default password **1 2 3 4 5 6**.

Regaining Default OWNER Password

The OWNER password is reset to default value as described above, except that the restore code must be provided by the manufacturer.

Charge Tone 2.1
Traffic Logging 2.3
Access Code 2.13

General

Each telephone port can be programmed to send a tone when the remote end subscriber answers and charging commences, for use with a card telephone or other debiting systems.

To avoid unauthorized use, setting of the function can be protected by means of two password levels: "**Renter/Owner Level**".

Frequency and length of the charge tone is set with function no. 80, *see next page (the same tone is sent on all ports selected)*.

Selection of ports to send charge tone is made with function no. 89, *see below*.

Selecting Ports to Send Charge Tone

1 Select **ENHANCED SETUP** function (89):

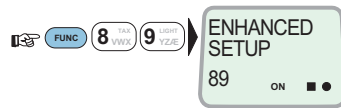

2 Check which ports are currently selected, e.g. TEL.3 and TEL.5:



If no ports are set:

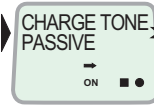

Current operation status (all operations require OWNER level):

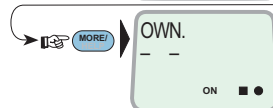

*If PASSWORD PROTECTED, refer to "**Renter/Owner Level**".*

3 Change selection to ports TEL.1 and 4: *0=handset, 1-5=connectors TEL.1-5 (Use DEL to deselect ports)*



4 Assign operation access level, e.g. 3: *2=operator (OPER), 3=renter (RENT) 4=owner (OWN)*



5 Verify settings:

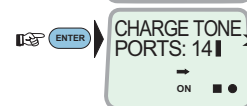

and revert to IDLE:



3x **ESC**

Charge Tone Cont'd

Frequency and Length

1 Select **CHARGE TONE SETUP** function (80):



2 Check current tone frequency and length:



3 Change frequency to e.g. 2800 Hz:



*Valid value: 400 – 3400 Hz,
or 0 – 15 for selection of DTMF tones:*



4 Change length to e.g. 400 ms:



*Valid value: 10 – 5000
milliseconds (0.01 – 5 seconds):*

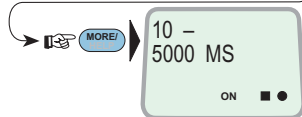

5 Verify settings:

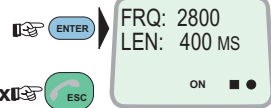

and revert to IDLE:



General

Each telephone port can be configured for logging of the following data:

- Destination address (B subscriber's number)
- Date and time of call
- Call duration
- LES used
- User ID (to code protected ports only, see "**Access Code**".)
- Port designation

To avoid unauthorized use, the function can be protected by password levels: see "**Renter/Owner Level**".

The following tasks can be allocated:

- SETUP OPE. – selection of ports to be logged, and clearing of logs. (default access level: OWNER).
- UPDATE OPE. – defining levels that can delete and flush logs (default access level: OWNER).
- VIEW OPE. – reading and printout of logs (default access level: OPERATOR)

Setting of ports to be logged and access levels is made with the "Enhanced Setup" function no. 89, see "**Selecting Ports and Access Level**" on next page.

Shortcut

For daily routine, you may print out the traffic log using the shortcut **SHIFT + PLAY**:

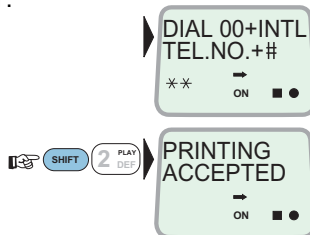

This will print and flush the time log, see "**TIME Log Output**".
Make sure that the user level is appropriate.

Traffic Logging Cont'd

Selecting Ports and Access Level

1 Select **ENHANCED SETUP** function (89):



2 Check which ports are currently logged, e.g. TEL.3 and TEL.5:



If no ports are logged:



*Current operation status (SETUP and UPDATE operations require OWNER level, VIEW operation requires OPERATOR level):
If PASSWORD PROTECTED, refer to "Renter/Owner Level".*



3 Change selection to ports HANDSET and TEL.4:
0=handset, 1-5=TEL.1 - 5, 6=DTE
(Use DEL to deselect ports)

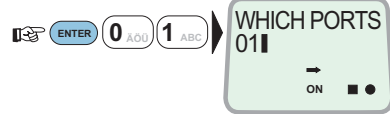

4 Assign operation access levels, e.g.:

*2=operator (OPER)
3=renter (RENT)
4=owner (OWN)*

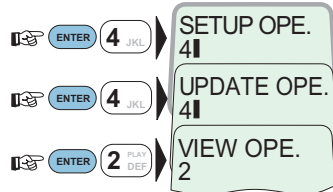

5 Verify settings:



and revert to IDLE:

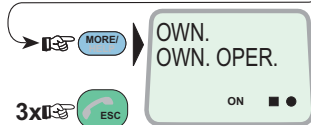

Selecting Destination and Autoprint

1 Select **TRAFFIC LOG SETUP** function (82):



2 Check current destination of flush printout, and number calls before automatic printout:
0=no autoprintout, 1=computer formatted printout (without heading etc.) after every call.

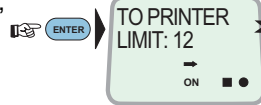

*Autoflushing of USER log ENABLED
 Autoflushing of PORT log DISABLED*

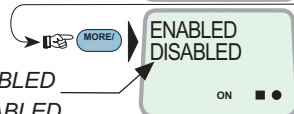

3 Key in destination, e.g. 2 (to printer):
0=no output, 2=to printer, 3=to DTE port (DTE is the only choice for Saturn MiniPhone)

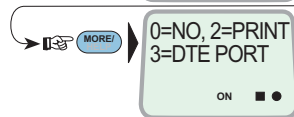

4 Key in number of calls before printout:
1 - 100 records, 0=disabled, 1=computer formatted printout after every call

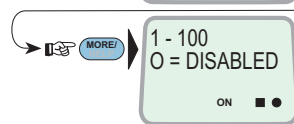

5 Choose whether or not the user log should be flushed automatically when full:

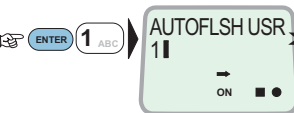

6 Choose whether or not the port log should be flushed automatically when full:
Automatic flush: printout after 100 calls, and log is reset.

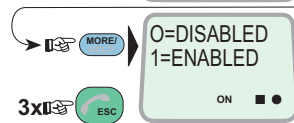
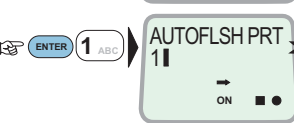

Revert to IDLE:



Traffic Logging Cont'd

Traffic Log Output

The "Traffic Log" function no.81 provides three types of call logs:

- **TIME LOG** – which sorts all calls by date/time
- **USER LOG** – which sorts calls by selected user ID
- **PORT LOG** – which sorts calls from selected port

Each log can be output in three ways:

- **VIEW** – scrolling through list
- **PRINT** – printout of list (without deleting printed records)
- **FLUSH** – print/deletion of logged data
- **VIEW HISTORY LOG** – which lists the 100 last calls (also the data that have been FLUSHED).

Selection of logs is made as follows:

1 Select **TRAFFIC LOG** function (81):

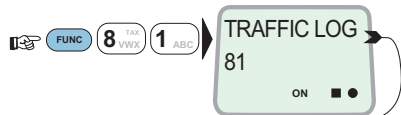

2 Select **TIME LOG (A)**:
(sorted by date/time)
See "**TIME Log Output**" for further information.

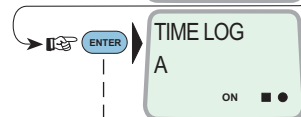

3 Select **USER LOG (B)**:
(sorted by User ID)
See "**USER Log Output**" for further information.

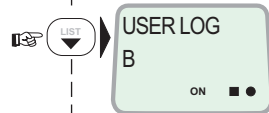

4 Select **PORT LOG (C)**:
(sorted within selected end terminal)
See "**PORT Log Output**" for further information.



Deleting Traffic Log Data

Deletion of **all** traffic log data can only be achieved when in OWNER level:

1 Select **TRAFFIC LOG** function (81):



2 Press and **hold** the **DEL** key:
and
press the **Y**-key to delete traffic logs:



TIME Log Output

The **TIME LOG** lists calls by datetime.

1 Select **TRAFFIC LOG LOG** function (81):

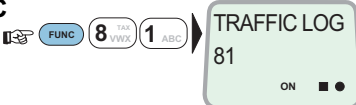

2 Select **TIME LOG (A)**:
(sorted by date/time)



3 Select view log mode:

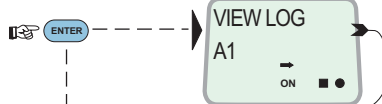

and scroll through list of calls to read data:

Note!
For routing to printer, see
"Various Configurations"
in the Saturn B Operator's
Manual.

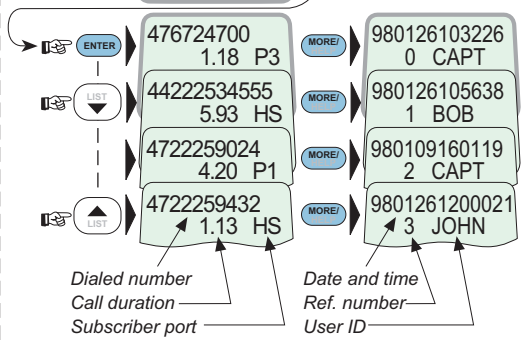

4 Scroll down to print log mode:



See next page for example of TIME LOG printout.

5 To flush TIME LOG only:



See next page for example of FLUSH LOG printout.

6 Select view history mode to read the last 100 records:



Lists calls as for VIEW LOG above.

7 Select print history mode to read the last 100 records:



See example of HISTORY LOG printout.

Revert to IDLE:



Traffic Logging Cont'd

Traffic Logging Cont'd

Example of **TIME LOG** printout:

The **PRINT LOG** command lists calls by date/time.

Ref. no. Port User access name Ocean Region Land Earth Station Dialed number Start date and time Call duration in minutes and 1/100 of a minute

```

===== Traffic log =====
Ref Src UserID OReg LES Dialed number Start date/time Duration
-----
000 P3 CAPT AOR-E 004 004767244700 950426 10:32:26 1.18
001 HS BOB IOR 011 0044222534555 950426 10:56:38 5.93
002 P1 CAPT AOR-E 004 004722259024 950426 11:38:48 4.20
003 HS JOHN IOR 004 004722259432 950426 12:00:21 1.13

Total duration is 12.44 minutes
4 records printed 95.04.27 11:01:02
    
```

Accumulated time Number of records

Example of computer formatted **TIME LOG** printout (one record only):

```

002 P1 CAPT AOR-E 004 004722259024 950426 11:38:48 4.20
    
```

Example of **FLUSH LOG** printout:

The **FLUSH LOG** prints deleted records. Deleted records can still be read with **VIEW** or **PRINT HISTORY LOG**.

```

#####
##### Traffic log #####
Ref Src UserID OReg LES Dialed number Start date/time Duration
-----
000 P3 CAPT AOR-E 004 004767244700 950426 10:32:26 1.18
001 HS BOB IOR 011 0044222534555 950426 10:56:38 5.93
002 P1 CAPT AOR-E 004 004722259024 950426 11:38:48 4.20
003 HS JOHN IOR 004 004722259432 950426 12:00:21 1.13

Total duration is 12.44 minutes

4 records printed 95.04.28 11:01:02
    
```

Example of HISTORY LOG output:

The HISTORY LOG printout lists the last 100 records, including the ones that have been flushed manually or automatically.

```

=====
----- Traffic log -----
-----
Ref Src UserID  OReg  LES Dialed number      Start date/time Duration
-----
000 P3  CAPT    AOR-E 004 004767244700      950426 10:32:26   1.18 *
001 HS  BOB     IOR   011 0044222534555      950426 10:56:38   5.93 *
002 P1  CAPT    AOR-E 004 004722259024      950426 11:38:48   4.20 *
003 HS  JOHN    IOR   004 004722259432      950426 12:00:21   1.13 *
004 P1  JOHN    IOR   004 004766845632      950427 08:22:13   2.17
005 HS  BOB     IOR   011 0044222534555      950427 10:43:30   3.88
006 P3  CAPT    AOR-E 004 004767244700      950426 12:37:22   7.78
007 P1  JOHN    IOR   004 004766845632      950427 16:10:10   6.15

Total duration is    32.42 minutes

      8 records printed 95.04.28 11:01:02

```

The star indicates that the records previously have been flushed from the TIME , USER or PORT LOG. They are still stored in the HISTORY LOG (the last 100 records), and are only printed when activating the PRINT HISTORY LOG command.

Traffic Logging Cont'd

Example of USER LOG printout:

```

=====
----- Traffic log for user CAPT -----
-----
Ref Src UserID  OReg  LES Dialed number      Start date/time Duration
-----
000 P3  CAPT    AOR-E 004 004767244700      950426 10:32:26   1.18
002 P1  CAPT    AOR-E 004 004722259024      950426 11:38:48   4.20

Total duration is    5.38 minutes

      2 records printed 95.04.27 11:01:32

```

Traffic Logging Cont'd

USER Log Output

The **USER LOG** lists calls made from a particular user. The user must be provided with access code, (otherwise the message "UNKNOWN USER" is displayed):

1 Select **TRAFFIC LOG**

LOG function (81): **8** **1**

TRAFFIC LOG
81
ON ■●

2 Select **USER LOG (B)**:

(sorted by user ID)

USER LOG
B
→ ON ■●

3 Select view user log mode:

VIEW USER
B1
→ ON ■●

and scroll down to required user:

SELECT USER:
CAPT

SELECT USER:
BOB

SELECT USER:
JOHN

4767244700
1.18 P3

950426103226
0 CAPT

4722259024
4.20 P1

950509160119
2 CAPT

4 Scroll down to print user log mode:

PRINT USER
B2
→ ON ■●

See previous page for example of USER LOG printout.

5 To flush user log only:

FLUSH USER
B3
→ ON ■●

Scroll down to required user and press ENTER:

SELECT USER:
CAPT

SELECT USER:
BOB

SELECT USER:
JOHN

Revert to IDLE:

3x

PORT Log Output

The **PORT LOG** lists calls made from a particular end terminal:

1 Select **TRAFFIC LOG**

LOG function (81):

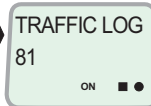

2 Select **PORT LOG (C)**:

(sorted within selected port)

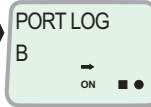

3 Select view port log mode:

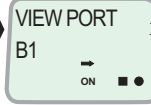

and scroll down to required port:

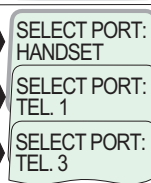

to read data:

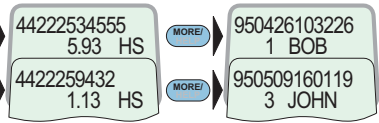

4 Scroll down to print port log mode:

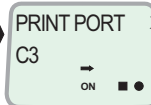

See next page for example of PORT LOG printout.

5 To flush port log only:

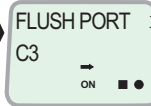

Scroll down to required port and press ENTER:



Revert to IDLE:



Traffic Logging Cont'd

Example of PORT LOG printout:

```

=====
===== Traffic log for port HANDSET =====
-----
Ref Src UserID  OReg  LES Dialed number      Start date/time Duration
-----
001 HS  BOB      IOR   011 0044222534555      950426 10:56:38  5.93
003 HS  JOHN     IOR   004 004722259432      950426 12:00:21  1.13

Total duration is 7.06 minutes

2 records printed 95.04.27 11:01:53

=====
===== Traffic log for port TEL.1 =====
-----
Ref Src UserID  OReg  LES Dialed number      Start date/time Duration
-----
002 P1  CAPT     AOR-E 004 004722259024      950426 11:38:48  4.20

Total duration is 4.20 minutes

1 records printed 95.04.27 11:02:06

```

Traffic Logging Cont'd

Printing a Single Record

A printout of a "Specific record in traffic log" is achieved whenever selecting an entry from **VIEW LOG**, **VIEW HISTORY LOG**, **VIEW USER** or **VIEW PORT**, and then keying **SHIFT + PLAY**:

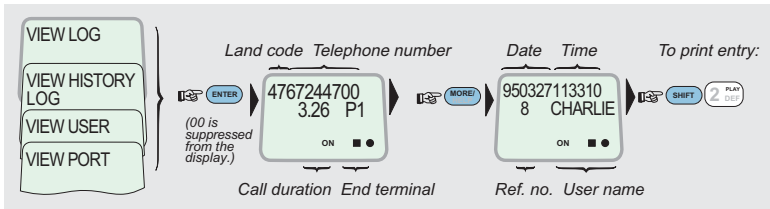

```

=====
===== Specific record in traffic log =====
-----
Ref Src UserID  OReg  LES Dialed number      Start date/time Duration
-----
008 HS  CHARLIE  AOR-E 004 004767244700      950327 11:33:10  3.26

1 record printed 95.03.30 12:01:15

```

Access code protection is recommended used on all ports configured for connection of telephone.

Selecting Ports for Access Protection

1 Select **ENHANCED SETUP** function (89):



2 Scroll down to check Access Code state:



If no ports are access code protected:

Current operation status (SETUP and UPDATE operations require RENTER level):

If PASSWORD PROTECTED, refer to "Setting Renter/Owner Level".

3 Change selection to ports HANDSET, TEL.1 and TEL.5: **ENTER** 0 **AOU** 1 **ABC** 5 **MND**
 0=handset, 1-5=TEL.1 - 5
 (Use DEL to deselect ports)

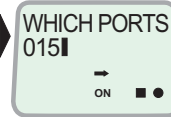

4 Assign operation access levels, e.g.: **ENTER** 4 **JKL**
 2=operator (OPER)
 3=renter (RENT)
 4=owner (OWN)

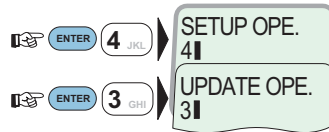

5 Verify settings:



and revert to IDLE:

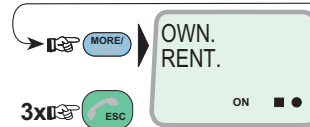

Access Code

Access Code Cont'd

Entering Name and PIN Code

The chosen name and PIN code apply to all ports activated for access protection. The PIN code is requested when trying to dial from a protected port.

1 Select **ACCESS CODES** function (84):



2 Scroll through list:

If permitted to UPDATE, pressing MORE/HELP displays the PIN code.

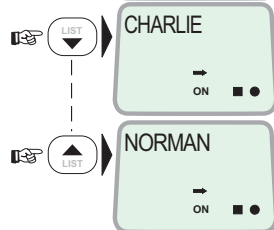

3 If required, press ENTER to edit name:



4 Scroll to top for new entry:



5 Key in user name:
8 letters/digits.

How to key letters: see Saturn M or B Operator's Manual.



6 Key in user code:
1 - 8 digits.



and revert to IDLE:



Making a Call when PIN Code Protected

After keying the first digit of the subscriber number, a dialing tone interrupts further keying and prompts you to enter your PIN code.

Example: 00 47 67 24 46 20 # 🎵 1 2 3 4 #

Subscriber number

PIN code

Precharge	3.1
Restricted LES	3.3
Restricted Dialing	3.4
Cryptophone STU III and STU IIB	3.5
Credit Card Phone	3.6

General

Saturn B/M can be preprogrammed with a total call duration limit of up to 500 hours and 59 minutes (ReMaIning time=RMN). A prewarning signal (---) sounds 5 minutes before reaching the remaining time limit. All terminal ports are automatically blocked if exceeding the preprogrammed limit.

The terminal can be provided with a special telephone number stored under short number **0**, which allows the user to call the owner to have the maximum total call limit prolonged even when having exceeded the time limit.

Activation

1 Select **ENHANCED SETUP** function (89):

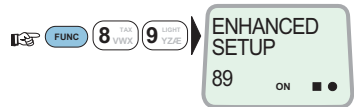

2 Scroll down to check the current Precharge state:



If not active:

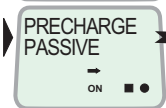

*Current operation status:
If PASSWORD PROTECTED, refer to "Renter/Owner Level".*



3 Activate the Precharge function:
0=passive, 1=active



4 Assign operation access level, e.g. 4:
2=OPERATOR, 3=RENTER, 4=OWNER



5 Verify settings:



and revert to IDLE:

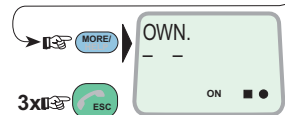

Precharge Cont'd

Extending the Remaining Time Limit

If exceeding the limit (message displayed: NO TIME LEFT, DIAL 230#), you can still call the owner using short number 0 (provided the owner has programmed the number), to have the time limit extended. (Calling short number 0 does not influence the remaining time limit).

The owner enters the new duration using the telephone (DTMF) or a PC; or he can read the number to the user for entry from the keypad.

Procedure

1 Call owner from handset:



2 When the owner answers, enter the "Call Duration" function to check current time elapsed (ex.):

*ReMaiNing time is 0 (max limit reached).
This call TIME is 10 minutes and 12/100 secs.
The TOTAL time 5 hours, 19 minutes and 47/100 seconds.
DEL key resets TIM/TOT.*

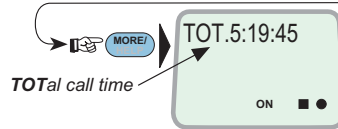

4 Read the random index to the owner: (The index is transmitted as DTMF tones. It changes every time short no. 0 is sent.)

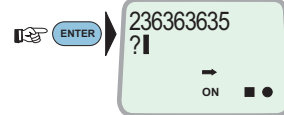

5 The owner will enter a number into your terminal that includes the FWD id and the extended remaining time in whole hours:

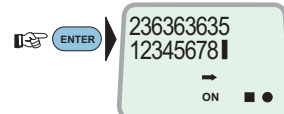

The data is entered using the telephone (DTMF) or a PC. The number can also be read across to the user for direct entry.



6 Check that the new ReMaiNing call time is correct:

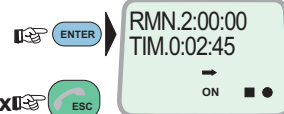

and revert to IDLE:



General

The terminal may be programmed to restrict calls from selected ports to be made through the **default** Land Earth Station for each Ocean Region.

Blocking an Ocean Region is achieved by setting its default Land Earth Station to LES0.

Activation

1 Select **ENHANCED SETUP** function (89):



2 Scroll down to check which ports are currently restricted:

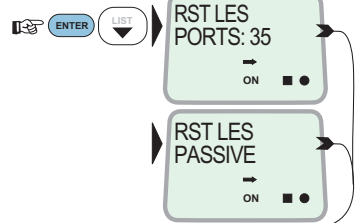

If no ports are LES restricted:

*Current operation status (SETUP operation requires OPERATOR level):
If PASSWORD PROTECTED, refer to "Renter/Owner Level".*

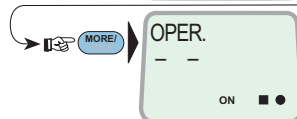

3 Select HANDSET and TEL. 1 ports: 0=handset, 1-5=TEL. 1 - 5 (Use DEL to deselect ports)

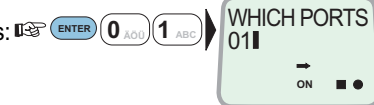

4 Assign operation access level, e.g. 4: 2=OPERATOR, 3=RENTER, 4=OWNER



5 Verify settings:



and revert to IDLE:

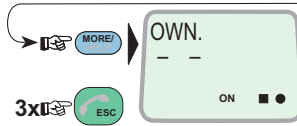

Restricted LES

Restricted Dialing

General

The terminal may be programmed to restrict calls from selected ports to be made from the short number list. It is thus possible to confine calls to preset areas, e.g.:

231#0047 – which fetches short number 1 (international call code and Norwegian country; *not changeable*), and then allows further dialing of the remaining local subscriber number, e.g.:
231#004766843121

Setting

1 Select **ENHANCED SETUP** function (89):

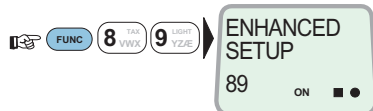

2 Scroll down to check which ports are currently restricted:



If no ports have restricted dialing:

Current operation status (SETUP operation requires OWNER level):

If PASSWORD PROTECTED, refer to "Renter/Owner Level".

3 Select HANDSET and TEL.1 ports: 0=handset, 1-5=TEL.1 - 5
(Use DEL to deselect ports)

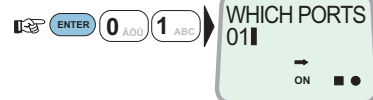

4 Key in "Setup Operation" access level, e.g. 3:

2=OPERATOR, 3=RENTER, 4=OWNER

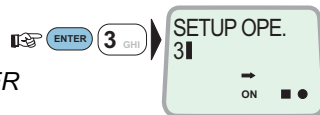

5 Verify settings:



and revert to IDLE:

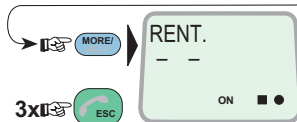

Cryptophone STU III and STU IIB

General

A Saturn terminal may be programmed to allow operation of encrypted speech through selected ports.
The encryption option requires the use of special type telephone.
An arrangement must also be made with the Land Earth Station.

Setting

1 Select **ENHANCED SETUP** function (89):



2 Scroll down to check which ports are set for connection of STU III or STU IIB phone:



If no ports are set:

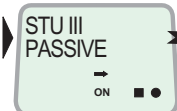

*Current operation status (SETUP operation requires OWNER level):
If PASSWORD PROTECTED, refer to "Renter/Owner Level".*

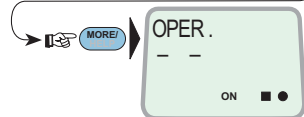

3 Select HANDSET and TEL. 1 ports: 0=handset, 1-5=TEL. 1 - 5
(Use DEL to deselect ports)

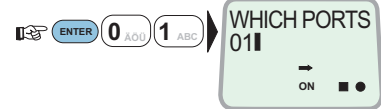

4 Key in "Setup Operation" access level, e.g. 4:
2=OPERATOR, 3=RENTER, 4=OWNER

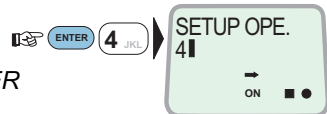

5 Verify settings:



and revert to IDLE:

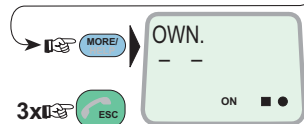

Cryptophone STU III

Credit Card Phone

General

A Saturn B/M terminal may be programmed to allow connection of Credit Card Telephone(s) to selected port(s).

Setting

1 Select **ENHANCED SETUP** function (89):

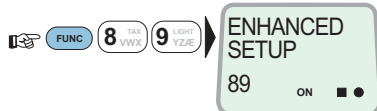

2 Scroll down to check which ports are set for connection of credit card phone:



If no ports are set:



*Current operation status (SETUP operation requires OWNER level):
If PASSWORD PROTECTED, refer to "Renter/Owner Level".*



3 Select TEL.3 and TEL.5 ports: 1-5=TEL.1 - 5
(Use DEL to deselect ports)



4 Key in "Setup Operation" access level, e.g. 4:
2=OPERATOR, 3=RENTER, 4=OWNER

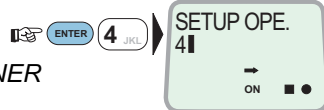

5 Verify settings:



and revert to IDLE:

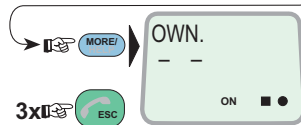

Dialing from Credit Card Telephone:

- 1** Lift handset and wait for the Credit Card dial tone (340 Hz).
- 2** Pull the credit card through the card reader and wait for the PIN tone (540 Hz).
- 3** Enter the PIN code (maximum 8 digits), and press **#**.
If no PIN code, press **#** only.
- 4** Wait for standard dial tone, and key in the telephone number.



Nera SatCom AS

Marine & Mobile

P.O.Box 91, N-1375 BILLINGSTAD, Norway

Phone: +47 67 24 47 00

Telex: 71721 umeb n

Telefax: +47 67 24 46 21

Website: <http://www.nera.satcom.no>